

PAFILI



User Manual: 1.8m Light-Duty Frame

pafili.com.au

Contents

DESCRIPTION & ERECTION	3
SAFE WORKING LOADS.....	5
PRACTICAL TIPS.....	7
APPENDIX A: LOAD TESTING SPECIFICATIONS.....	8
APPENDIX B: PHOTOS OF TESTING	9

Please read this manual carefully to ensure correct use of the PAFILI shoring system. The largest construction companies around the world have confidently entrusted their projects to PAFILI. We are certain you will benefit from the quality, proven safety and reduced construction time that PAFILI offers.

All specifications, descriptions and procedures in this manual are accurate at the time of printing. Because of PAFILI's policy of continued product improvement, we reserve the right to make changes at any time without notice.

The information in this document complies with AS 3610: Formwork for Concrete as amended.

DESCRIPTION & ERECTION

The PAFILI shoring system is used for the support of concrete formwork, such as for commercial buildings. The simplest system is an assembled shoring tower, comprising the following three structural steel components:

- **Frames**



Frame tube= 48.8mm outside diameter, 3.2mm thickness

- **Crossbraces**

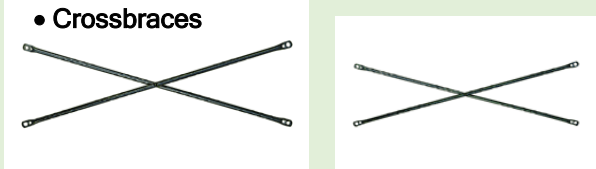

Brace tube = 27mm outside diameter, 2mm thickness

- **Adjustable U-Heads & Base Jacks**



Jack tubes = 40.0mm outside diameter, 5mm thickness

The cover page shows a tower configuration formed from pairs of frames braced by two diagonal crossbraces secured to pins welded to the frame legs.

Adjustable base jacks are inserted in the bottom ends of all frame legs to provide leveling for overall height adjustment and to compensate for local variations in the supporting surface. Adjustable U-heads are inserted in the top of the frames to support bearers, and subsequently joists, and to provide final height adjustment to these members.

Towers may be assembled with the loads applied through the U-Heads with the primary bearer running perpendicular to the frames or parallel to the frames (see Safe Working Loads section).

Towers can be formed to a defined height using a combination of frames of both heights, provided that same height frames are used as a pair at each level (see picture on page 4).

Frame connectors are used to connect frames to the desired height.

- **Frame Connector (Spigot, Joiner)**



DESCRIPTION & ERECTION (Cont'd)

When frame towers are erected more than 1 frame in height, the following conditions are to be considered:

1, 2 or 3 frames high:

- Pafili guidelines are to be followed generally (refer to page 5 precautions)
- Leg loads shall be within permissible limits
- Frame towers shall be plumb
- All braces to be in position prior to pour
- Eccentricity shall be eliminated or minimized, or checked by an engineer

Important: any lateral support required (eg. to resist horizontal forces) shall have to be considered by the formworker and engineer.

4 or more frames high:

- Same as for up to 3 frames high, plus: subject to leg-loads, formwork layout, location of project and some other factors, it may become necessary to brace the towers using tubes and couplers at regular intervals in both (ie 2)

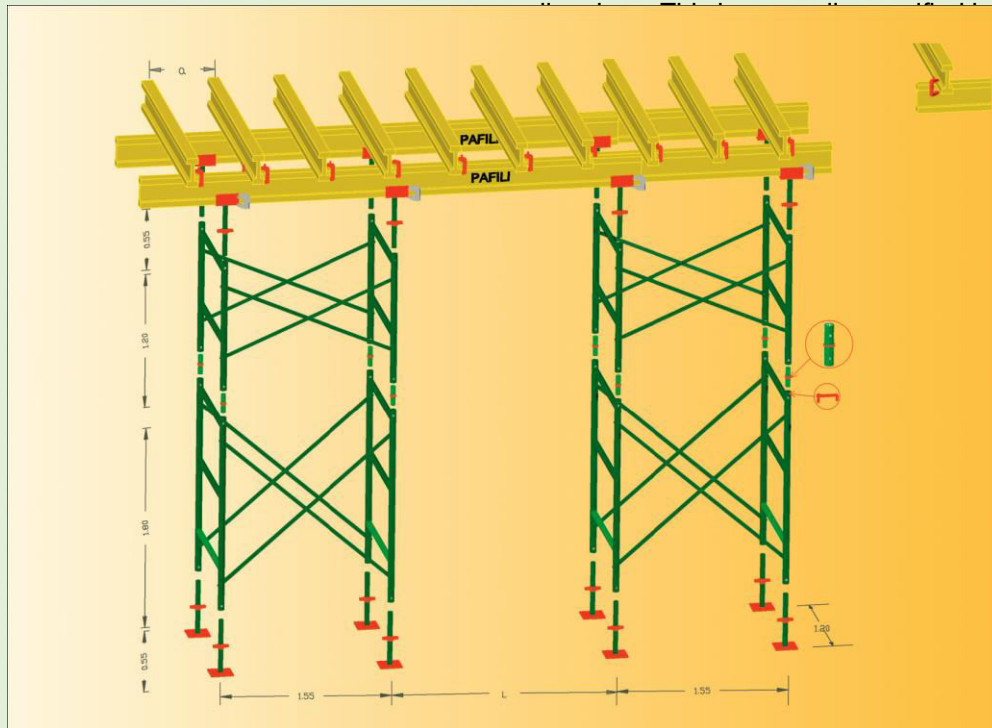

SAFE WORKING LOADS

Safe Working Load per Leg - Beams are at right angles to frames

(Strong Direction)

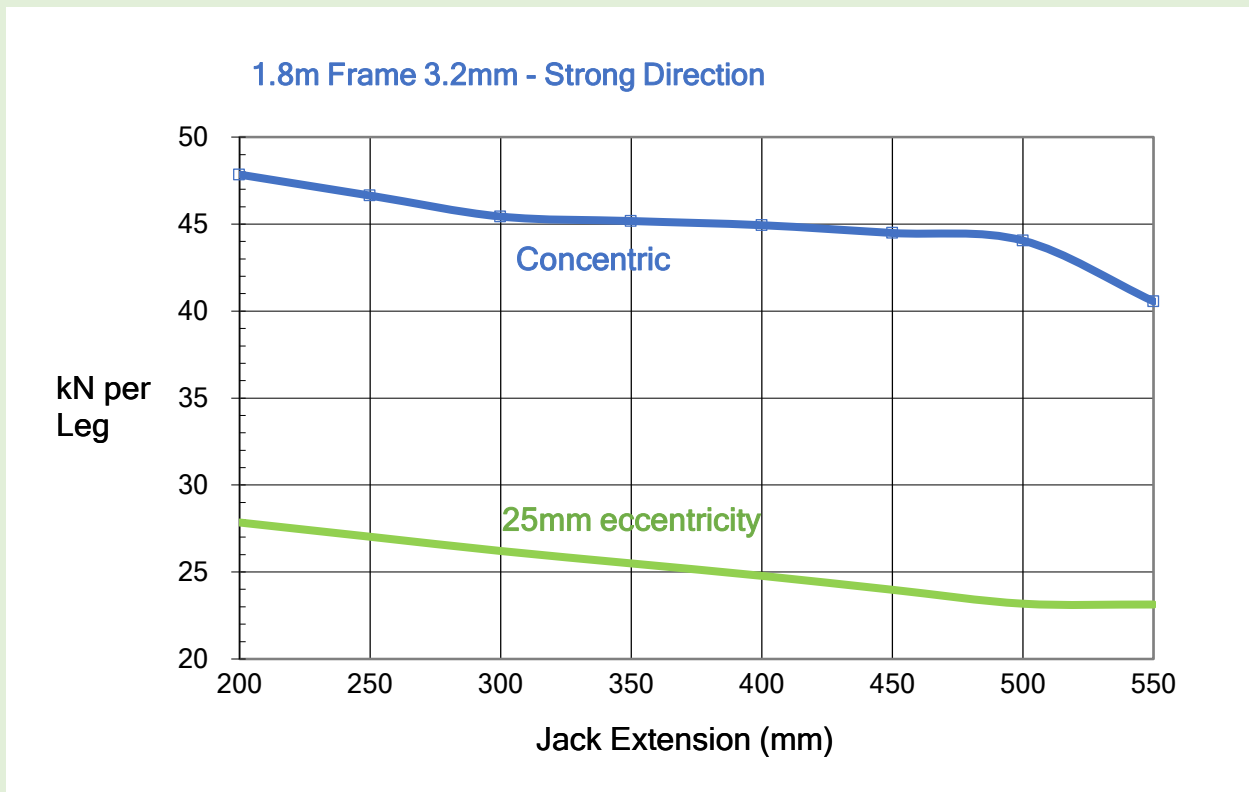

Note: Because of PAFILI's policy of continued product improvement, we reserve the right to make changes at any time without notice. PAFILI products must be used in accordance with all PAFILI precautions and erection procedures provided in this document, the industry-approved codes of practice, AS3610, OH&S Act, and any other requirements by a statutory or regulatory body. The use of PAFILI products in a manner other than that intended will render the Safe Working Loads void. **Limit state conversion factor = 1.5**

Safe Working Load per Leg - Beams are parallel to frames

(Weak Direction)

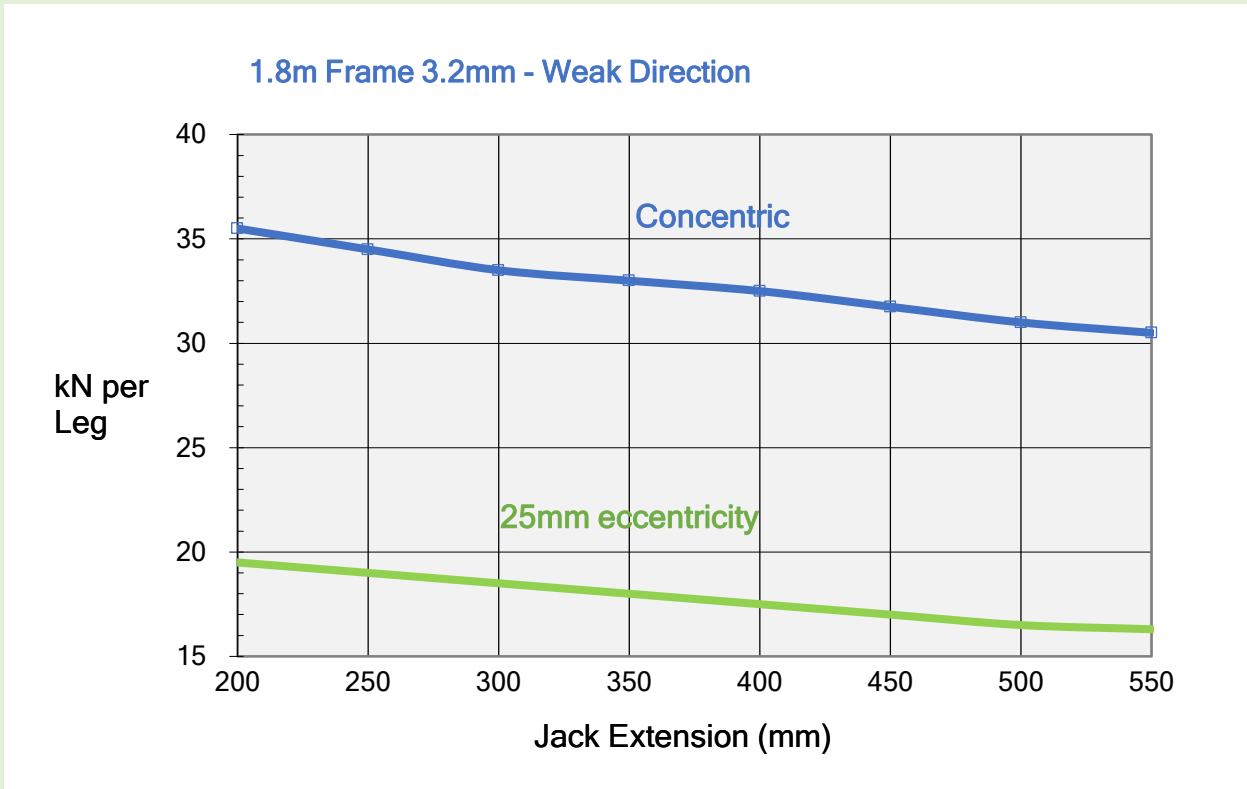

Note: Because of PAFILI's policy of continued product improvement, we reserve the right to make changes at any time without notice. PAFILI products must be used in accordance with all PAFILI precautions and erection procedures provided in this document, the industry-approved codes of practice, AS3610, OH&S Act, and any other requirements by a statutory or regulatory body. The use of PAFILI products in a manner other than that intended will render the Safe Working Loads void. **Limit state conversion factor = 1.5**

PRACTICAL TIPS

- The supporting surface for formwork frames must have sufficient strength to support the loads of the frames, the formwork, concrete placed on the formwork and future work on the hardened concrete surface. Soils must be compacted to support such loads. Soleplates used under the base plates of the bottom jacks and the supporting surface must have sufficient strength to support the loads on the frames without undue settlement. Previously placed concrete surfaces may require soleplates to prevent surface damage to the concrete or undue concentration of the loads under the base jacks.
- Tower assemblies more than 1-frame high shall be connected using frame connectors.
- Where it is necessary to erect frames more than 1.80m high a system must be developed for working at heights to prevent falls. Local regulations must be consulted to ensure that the selected work practice, including access to the upper levels, complies with the regulations.
- A bearer must extend bear on the full length of the U-head. A single bearer must be centred on the U-head. Where the bearer is narrower than the opening in the U-head, the U-Head should be twisted to ensure that the bearer remains at the centre. Where two bearers are required to land on a U-head they must not be end butted but must pass each other to achieve full bearing on the surface of the U-head.
- Additional bracing tubes connected to the frame legs may be required where lateral forces or additional loads are to be considered.
- Frames stacked on site may be unstable depending on the form of the stack. Care must be taken to ensure that injuries do not occur when working around stacked frames.
- Non-PAFILI components should not be substituted for PAFILI components. Violation of this will invalidate the PAFILI Safe Working Loads.
- PAFILI products must be used in accordance with PAFILI technical specifications, the industry-approved codes of practice, AS3610, OH&S Act, and any other requirements by a statutory or regulatory body.

APPENDIX A: LOAD TESTING SPECIFICATIONS

Testing to parts of AS 3610 as amended

TESTED BY: TESTSAFE AUSTRALIA www.testsafe.com.au
 919 Londonderry Rd, Londonderry NSW 2153
 WorkCover NSW is affiliated with TestSafe Australia

TEST EQUIPMENT:

- Enerpac Hydraulic Systems, with 4 cylinders of 0 to 20 tonne capacity each, Pump s/no. B1, Enerpac Pressure Gauges s/nos. W1 & W2
- Vernier - Mitutoyo s/no. 0025652
- Hydraulic Calibrator - Avery Universal Test Machine, s/no. LC 339
- Avery Testing Machine 7104DCJ s/no. LC340
- Tape Measure - Stanley 10m, s/no. TC2
- Rule, Rabone, s/no. LC1484
- Loading Frames, Oregon timber beams and offsets, loading tubes & dies, inclined plates

TEST METHOD: Assembled systems were tested in accordance with AS 3610 – 1995/ Amendment 1/2003-01-23 Formwork for Concrete. In addition, adjustable jacks included in the system were tested separately to AS 1576.2–1991 Scaffolding Part 2: Couplers and Accessories, Appendix G.

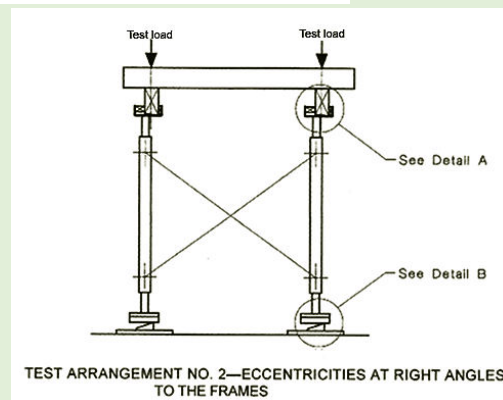
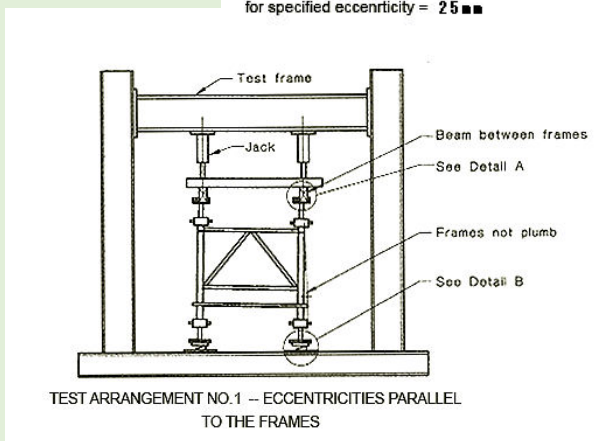
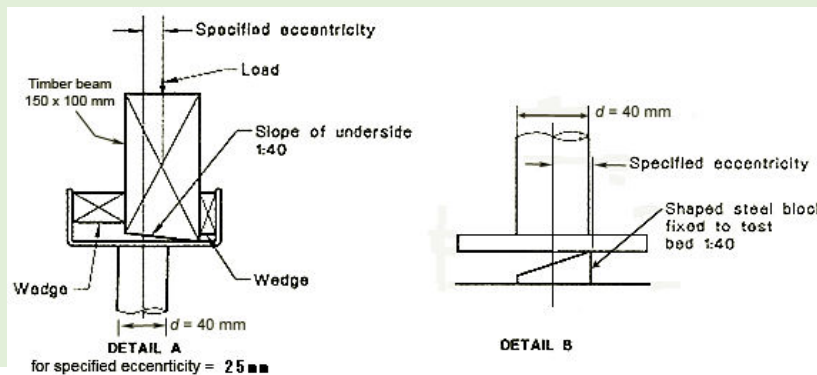

APPENDIX B: PHOTOS OF TESTING



PHOTO A: Test Arrangement



PHOTO B: Measuring effect of load application



PHOTO C: Measuring deformation of jacks



PHOTO D: Eccentric detail under load for Test Arrangement set-up (Load beams parallel to frames)